

145233-1 ✓ ACTIVE

CGS HS

TE Internal #: 145233-1

Housing, Receptacle, Wire-to-Board, 4 Position, 7.92 mm [.312 in]

Centerline, 1 Row, White, Wire & Cable, Power, Board Mount, CGS

HS

[View on TE.com >](#)



Connectors > PCB Connectors > Wire-to-Board Connectors > Wire-to-Board Connector Assemblies & Housings



Connector Product Type: **Housing**

Connector & Housing Type: **Receptacle**

Connector System: **Wire-to-Board**

Number of Positions: **4**

Centerline (Pitch): **7.92 mm [.312 in]**

## Features

### Product Type Features

Connector Product Type	Housing
Connector & Housing Type	Receptacle
Connector System	Wire-to-Board
Sealable	No
Connector & Contact Terminates To	Wire & Cable

### Configuration Features

Number of Positions	4
Number of Rows	1

### Contact Features

Contact Current Rating (Max)	30 A
------------------------------	------

### Mechanical Attachment

Mating Retention	Without
Connector Mounting Type	Board Mount



### Housing Features

Centerline (Pitch)	7.92 mm [.312 in]
Housing Color	White

### Usage Conditions

Operating Temperature Range	-40 – 95 °C [-40 – 203 °F]
-----------------------------	----------------------------

### Operation/Application

Circuit Application	Power
---------------------	-------

### Product Compliance

[For compliance documentation, visit the product page on TE.com>](#)

EU RoHS Directive 2011/65/EU	Compliant
EU ELV Directive 2000/53/EC	Compliant
China RoHS 2 Directive MIIT Order No 32, 2016	No Restricted Materials Above Threshold
EU REACH Regulation (EC) No. 1907/2006	Current ECHA Candidate List: JUNE 2022 (224) Candidate List Declared Against: JAN 2021 (211) Does not contain REACH SVHC
Halogen Content	Low Halogen - Br, Cl, F, I < 900 ppm per homogenous material. Also BFR/CFR/PVC Free
Solder Process Capability	Not applicable for solder process capability

#### Product Compliance Disclaimer

This information is provided based on reasonable inquiry of our suppliers and represents our current actual knowledge based on the information they provided. This information is subject to change. The part numbers that TE has identified as EU RoHS compliant have a maximum concentration of 0.1% by weight in homogenous materials for lead, hexavalent chromium, mercury, PBB, PBDE, DBP, BBP, DEHP, DIBP, and 0.01% for cadmium, or qualify for an exemption to these limits as defined in the Annexes of Directive 2011/65/EU (RoHS2). Finished electrical and electronic equipment products will be CE marked as required by Directive 2011/65/EU. Components may not be CE marked. Additionally, the part numbers that TE has identified as EU ELV compliant have a maximum concentration of 0.1% by weight in homogenous materials for lead, hexavalent chromium, and mercury, and 0.01% for cadmium, or qualify for an exemption to these limits as defined in the Annexes of Directive 2000/53/EC (ELV). Regarding the REACH Regulation, the information TE provides on SVHC in articles for this part number is based on the latest European Chemicals Agency (ECHA) 'Guidance on requirements for substances in articles' posted at this URL: <https://echa.europa.eu/guidance-documents/guidance-on-reach>

### Compatible Parts

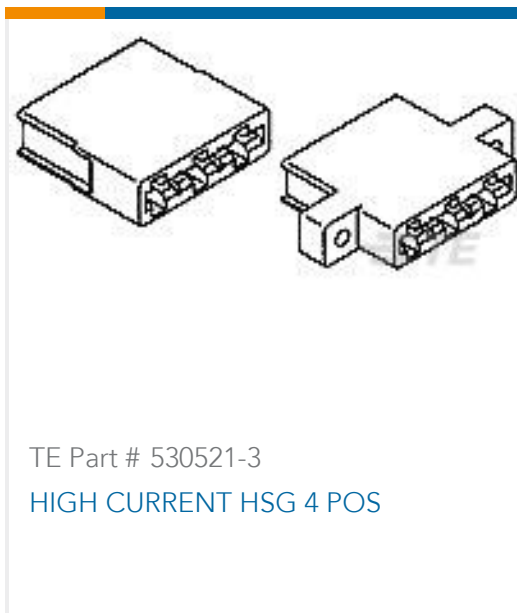

## Also in the Series | CGS HS

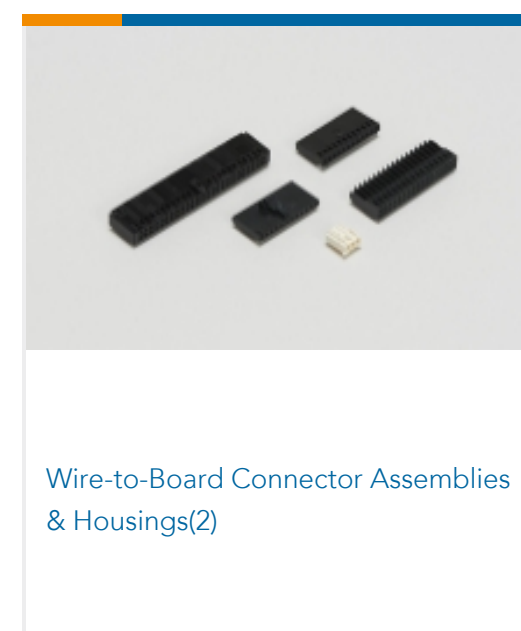
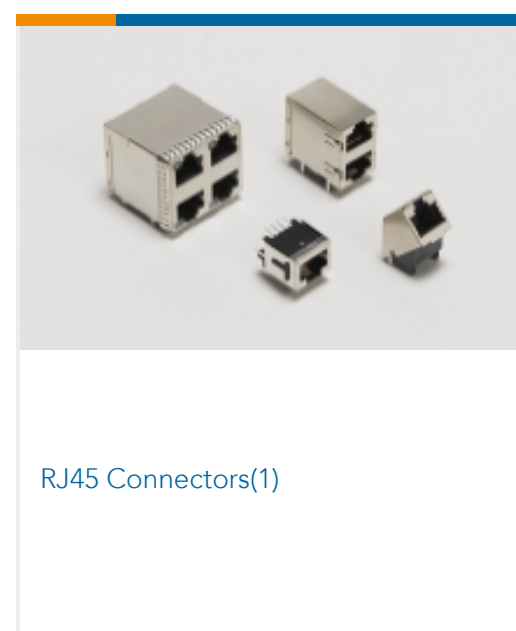
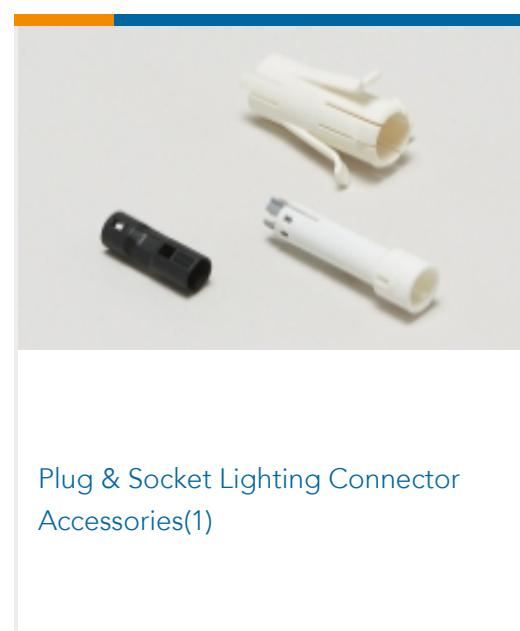
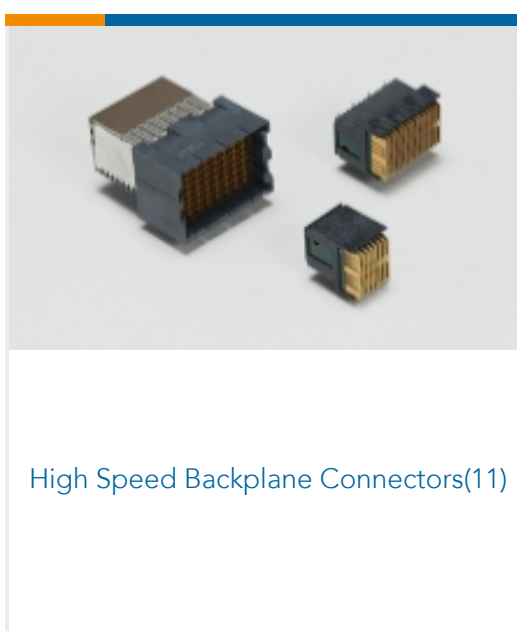
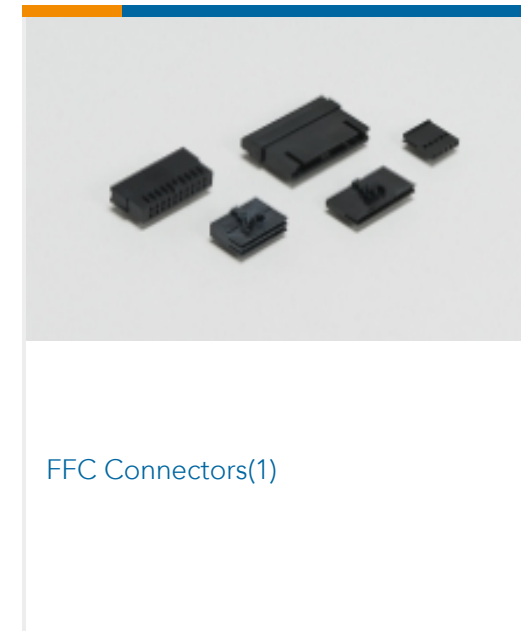
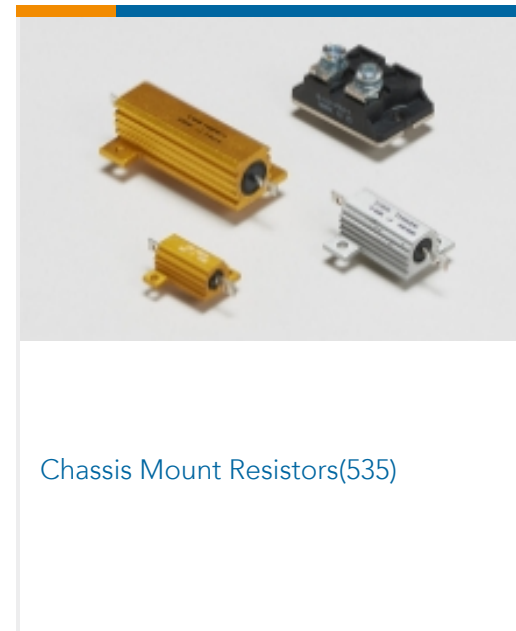
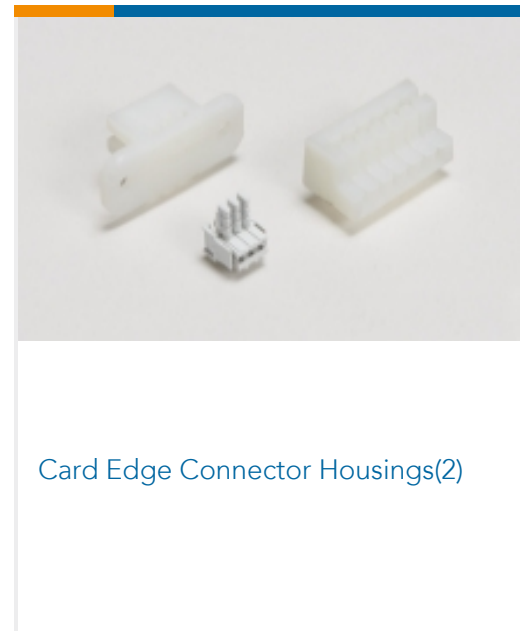
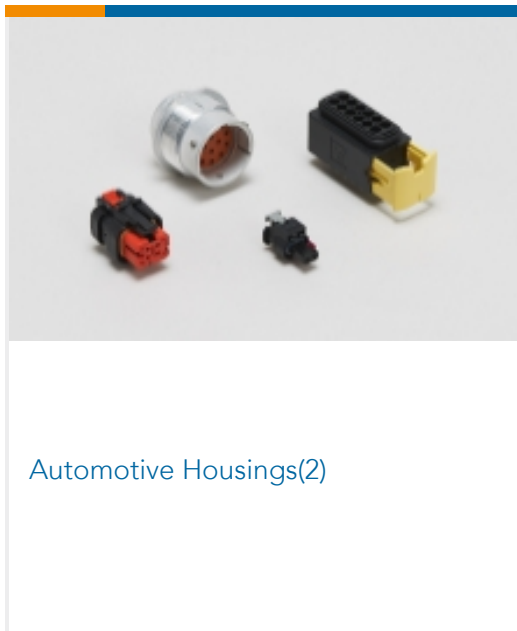

## Documents

### Product Drawings

#### HIGH CURRENT HSG 4 POS

English

### CAD Files

#### 3D PDF

3D

#### Customer View Model

[ENG\\_CVM\\_CVM\\_145233-1\\_D.2d\\_dxf.zip](#)

English

#### Customer View Model

[ENG\\_CVM\\_CVM\\_145233-1\\_D.3d\\_igs.zip](#)

English

#### Customer View Model

[ENG\\_CVM\\_CVM\\_145233-1\\_D.3d\\_stp.zip](#)

English

145233-1

Housing, Receptacle, Wire-to-Board, 4 Position, 7.92 mm [.312 in] Centerline, 1 Row,  
White, Wire & Cable, Power, Board Mount, CGS HS



By downloading the CAD file I accept and agree to the [Terms and Conditions](#) of use.

[Product Specifications](#)

[Application Specification](#)

English